

Ultra Low Dropout 1.5A Linear Regulator

General Description

The RT9183A series are high performance linear voltage regulators that provide ultra low dropout voltage, high output current with low ground current. It operates from an input of 2.3V to 5.5V and provides output current up to 1.5A thus is suitable to drive digital circuits requiring low voltage at high currents.

The RT9183A has superior regulation over variations in line and load. Also it provides fast respond to step changes in load. Other features include over current and over temperature protection. The adjustable version has enable pin to reduce power consumption in shutdown mode.

The devices are available in fixed output voltages of 1.2V to 3.3V with 0.1V per step and as an adjustable device with a 0.8V reference voltage. The RT9183A regulators are available in 3-lead SOT-223 and TO-263 packages (fixed output only for the 3-lead option). Also available are 5-lead TO-263, TO-252 and fused SOP-8 packages with two external resistors to set the output voltage ranges from 0.8V to 4.5V.

Applications

- Battery-Powered Equipment
- Mother Board/Graphic Card
- Peripheral Cards
- PCMCIA Card

Marking Information

For marking information, contact our sales representative directly or through a Richtek distributor located in your area.

Features

- **330mV Dropout @ 1.5A**
- **380uA Low Ground Pin Current**
- **Excellent Line and Load Regulation**
- **0.1µA Quiescent Current in Shutdown Mode**
- **Guaranteed 1.5A Output Current**
- **Fixed Output Voltages : 1.2V to 3.3V**
- **Adjustable Output Voltage from 0.8V to 4.5V**
- **Over Temperature/Over Current Protection**
- **RoHS Compliant and 100% Lead (Pb)-Free**

Ordering Information

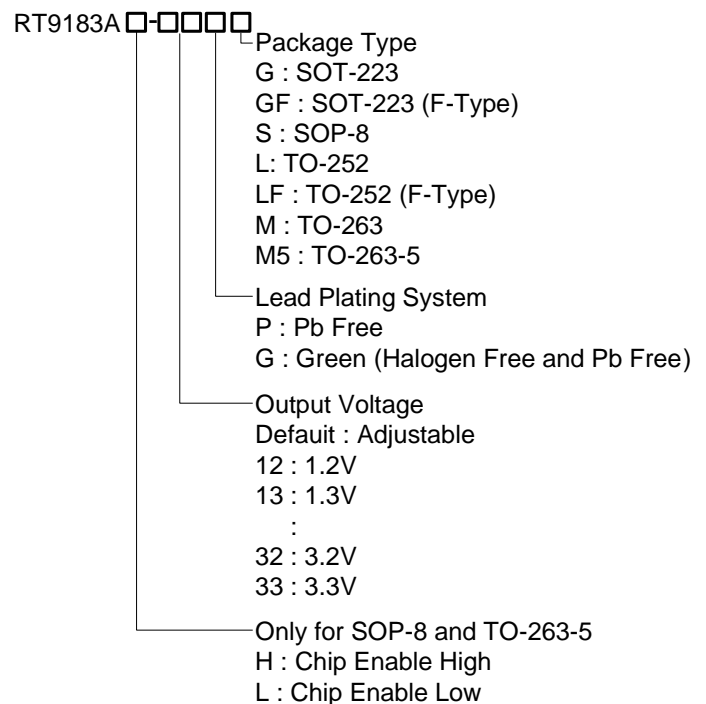

Note :

Richtek products are :

- ▶ RoHS compliant and compatible with the current requirements of IPC/JEDEC J-STD-020.
- ▶ Suitable for use in SnPb or Pb-free soldering processes.

Pin Configurations

(TOP VIEW)

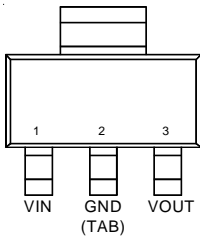

SOT-223

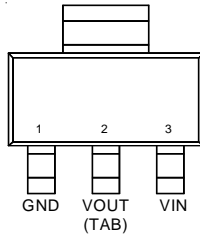

SOT-223 (F-Type)

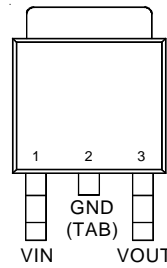

TO-252

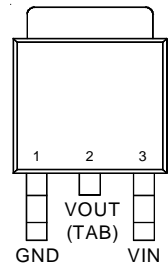

TO-252 (F-Type)

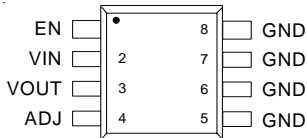

SOP-8

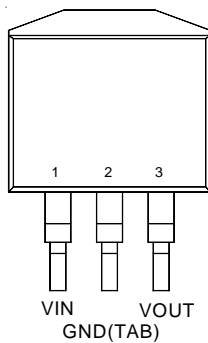

TO-263

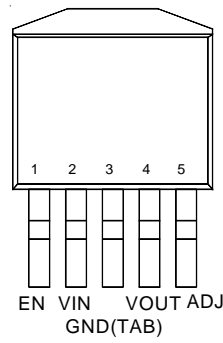

TO-263-5

Typical Application Circuit

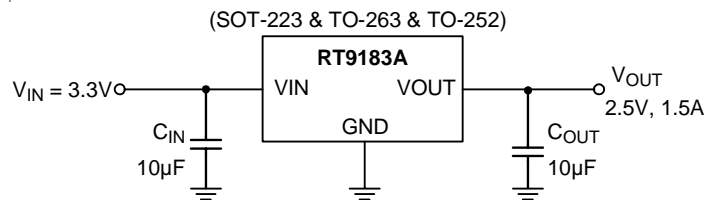
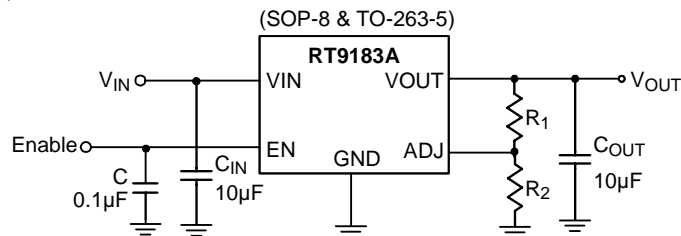

Figure 1. 3.3V to 2.5V Regulator



$$V_{OUT} = 0.8 \times \left(1 + \frac{R_1}{R_2}\right) \text{Volts}$$

Note: The value of R2 should be less than 80k to maintain regulation.

Figure 2. Adjustable Operation

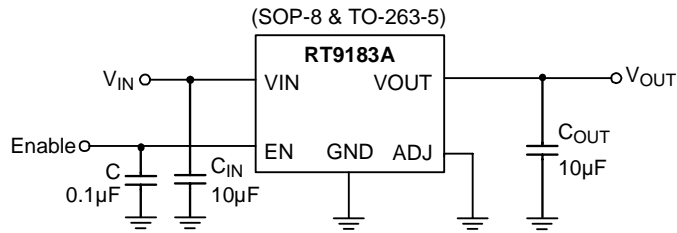
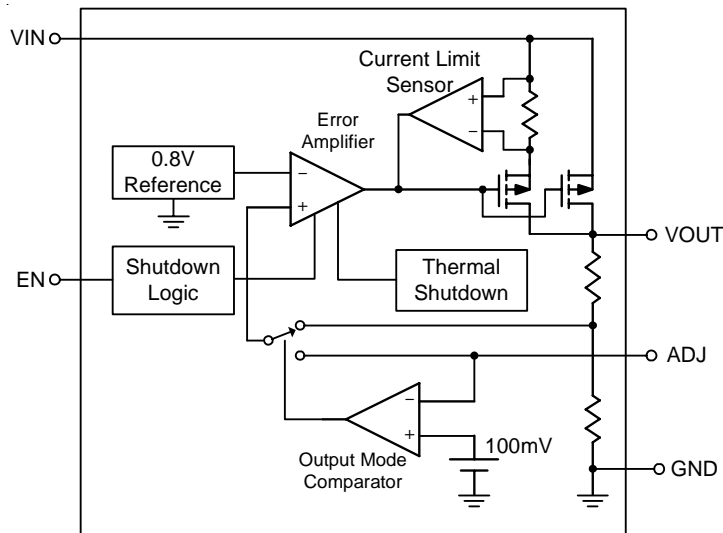

Figure 3. Fixed Operation with SOP-8 and TO-263-5 packages

Functional Pin Description

Pin Name	Pin Function
EN	Chip Enable Control Input. Note that the device will be in the unstable state if the pin is not connected.
VIN	Supply Input.
GND	Common Ground.
VOUT	Regulator Output.
ADJ	The output voltage is set by the internal feedback resistors when this pin grounded. If external feedback resistors are applied, the output voltage will be : $V_{OUT} = 0.8 \times \left(1 + \frac{R_1}{R_2}\right) \text{ Volts}$

Function Block Diagram



Absolute Maximum Ratings (Note 1)

- Supply Input Voltage ----- 6V
- Package Thermal Resistance (Note 2)
 - SOT-223, θ_{JA} ----- 115°C/W
 - SOT-223, θ_{JC} ----- 15°C/W
 - SOT-223 (F-Type), θ_{JA} ----- 135°C/W
 - SOT-223 (F-Type), θ_{JC} ----- 17°C/W
 - SOP-8, θ_{JA} ----- 125°C/W
 - SOP-8, θ_{JC} ----- 20°C/W
 - TO-252, θ_{JA} ----- 68°C/W
 - TO-252, θ_{JC} ----- 8°C/W
 - TO-252 (F-Type), θ_{JA} ----- 75°C/W
 - TO-252 (F-Type), θ_{JC} ----- 15°C/W
 - TO-263, θ_{JA} ----- 45°C/W
 - TO-263, θ_{JC} ----- 8°C/W
- Power Dissipation, $P_D@T_A = 25^\circ\text{C}$
 - SOT-223 ----- 0.87W
 - SOT-223 (F-Type) ----- 0.74W
 - SOP-8 ----- 0.8W
 - TO-252 ----- 1.471W
 - TO-252 (F-Type) ----- 1.333W
 - TO-263 ----- 2.22W
- Lead Temperature (Soldering, 10 sec.) ----- 260°C
- Junction Temperature ----- 150°C
- Storage Temperature Range ----- -65°C to 150°C
- ESD Susceptibility (Note 3)
 - HBM (Human Body Mode) ----- 2kV
 - MM (Machine Mode) ----- 200V

Recommended Operating Conditions (Note 4)

- Supply Input Voltage ----- 2.3V to 5.5V
- Junction Temperature Range ----- -40°C to 125°C

Electrical Characteristics

($V_{IN} = V_{OUT} + 0.7V$, $C_{IN} = C_{OUT} = 10\mu F$ (Ceramic), $T_A = 25^\circ\text{C}$ unless otherwise specified)

Parameter	Symbol	Test Conditions	Min	Typ	Max	Unit
Output Voltage Accuracy (Fixed Output Voltage)	ΔV_{OUT}	$I_{OUT} = 10\text{mA}$	-1	0	1	%
Output Voltage Range (Adjustable)	V_{OUT_ADJ}		0.8	--	4.5	V
Quiescent Current (Note 5)	I_Q	$I_{OUT} = 0\text{mA}$, Enable	--	380	500	μA
Standby Current (Note 6)	I_{STBY}	$V_{IN} = 5.5V$, Shutdown	--	0.1	1	μA

To be continued

Parameter		Symbol	Test Conditions	Min	Typ	Max	Unit
Current Limit		I_{LIM}		2	3.2	4.2	A
Dropout Voltage (Note 7)		V_{DROP}	$I_{OUT} = 0.5A$	--	110	300	mV
			$I_{OUT} = 1.0A$	--	220	400	
			$I_{OUT} = 1.5A$	--	330	500	
Line Regulation		ΔV_{LINE}	$V_{OUT} + 0.7V < V_{IN} < 5.5V$ $I_{OUT} = 10mA$	--	0.035	0.18	%/V
Load Regulation (Note 8) (Fixed Output Voltage)		ΔV_{LOAD}	$1mA < I_{OUT} < 1.5A$	--	22	45	mV
Thermal Shutdown Temperature		T_{SD}		--	170	--	°C
Thermal Shutdown Hysteresis		ΔT_{SD}		--	30	--	°C
EN Threshold	Logic-Low Voltage	V_{IL}	$V_{IN} = 5.5V$	--	--	0.6	V
	Logic-High Voltage	V_{IH}	$V_{IN} = 5.5V$	1.8	--	--	
Enable Pin Current		I_{EN}	$V_{IN} = 5.5V$, Enable	--	0.1	1	μA
ADJ							
Reference Voltage Tolerance		V_{REF}		0.792	0.8	0.808	V
Adjust Pin Current		I_{ADJ}	$V_{ADJ} = V_{REF}$	--	10	100	nA
Adjust Pin Threshold		$V_{TH(ADJ)}$		0.05	0.1	0.2	V

Note 1. Stresses listed as the above "Absolute Maximum Ratings" may cause permanent damage to the device. These are for stress ratings. Functional operation of the device at these or any other conditions beyond those indicated in the operational sections of the specifications is not implied. Exposure to absolute maximum rating conditions for extended periods may remain possibility to affect device reliability.

Note 2. θ_{JA} is measured in natural convection (still air) at $T_A = 25^\circ C$ with the component mounted on a low effective thermal conductivity test board of JEDEC 51-3 thermal measurement standard. And the copper area of PCB layout is 4mm x 2.5mm on SOT-223, 10mm x 10mm on TO-252, 14mm x 14mm on TO-263 for thermal measurement.

Note 3. Devices are ESD sensitive. Handling precaution is recommended.

Note 4. The device is not guaranteed to function outside its operating conditions.

Note 5. Quiescent, or ground current, is the difference between input and output currents. It is defined by $I_Q = I_{IN} - I_{OUT}$ under no load condition ($I_{OUT} = 0mA$). The total current drawn from the supply is the sum of the load current plus the ground pin current.

Note 6. Standby current is the input current drawn by a regulator when the output voltage is disabled by a shutdown signal ($V_{EN} > 1.8V$). It is measured with $V_{IN} = 5.5V$.

Note 7. The dropout voltage is defined as $V_{IN} - V_{OUT}$, which is measured when V_{OUT} is $V_{OUT(NORMAL)} - 100mV$.

Note 8. Regulation is measured at constant junction temperature by using a 20ms current pulse. Devices are tested for load regulation in the load range from 10mA to 1.5A.

Typical Operating Characteristics

Output Voltage vs. Temperature

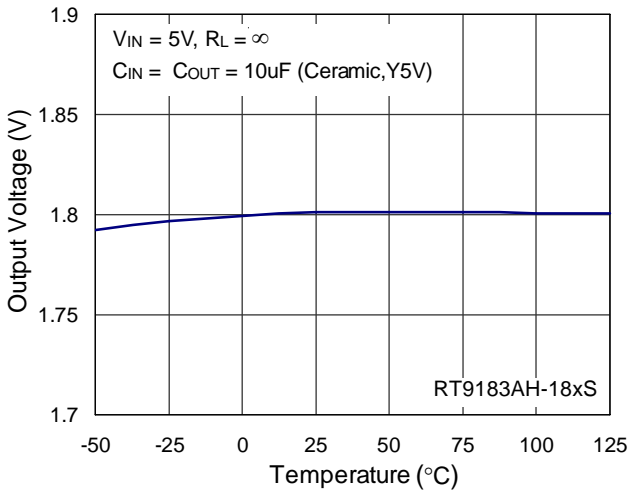

Output Voltage vs. Temperature

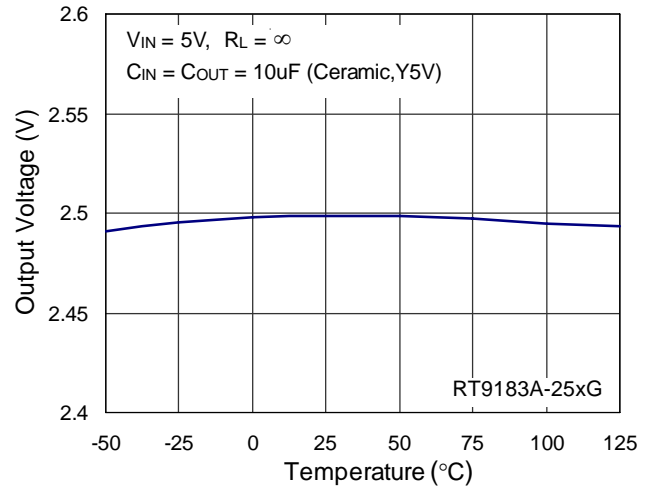

Quiescent Current vs. Temperature

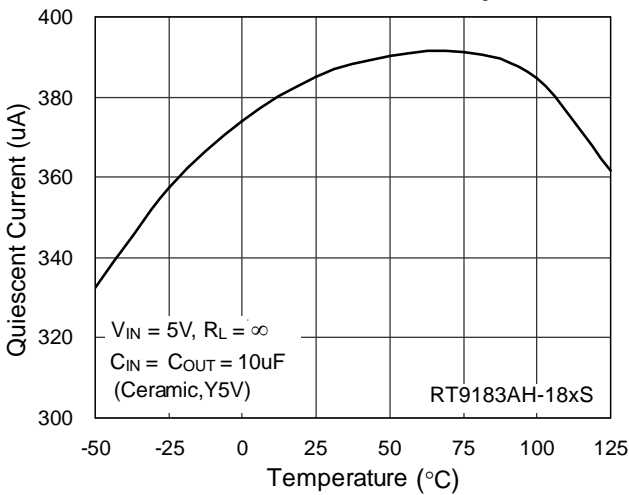

Quiescent Current vs. Temperature

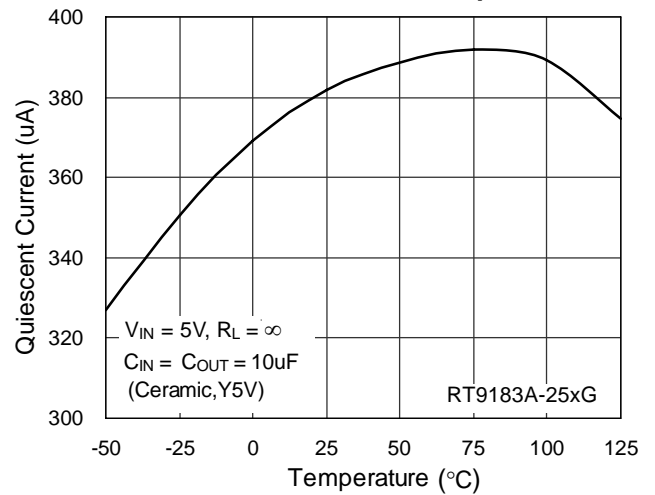

Current Limit vs. Temperature

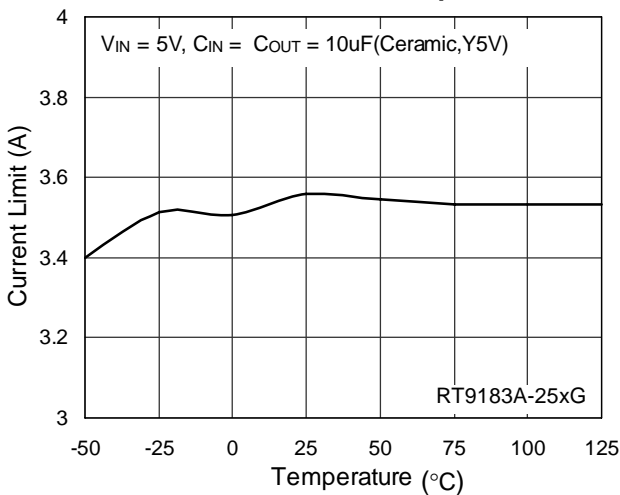

Current Limit vs. Temperature

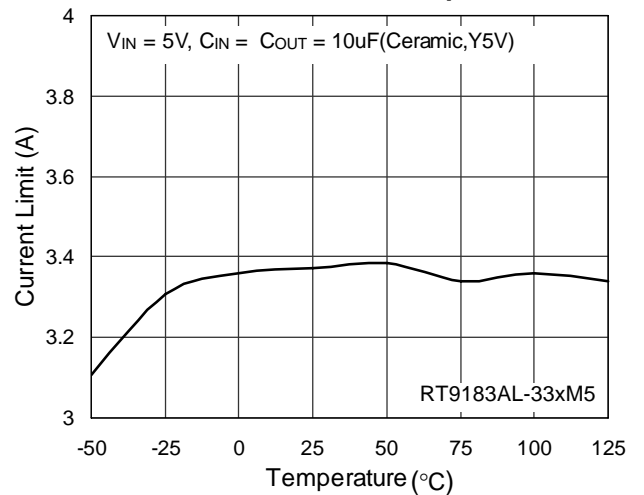

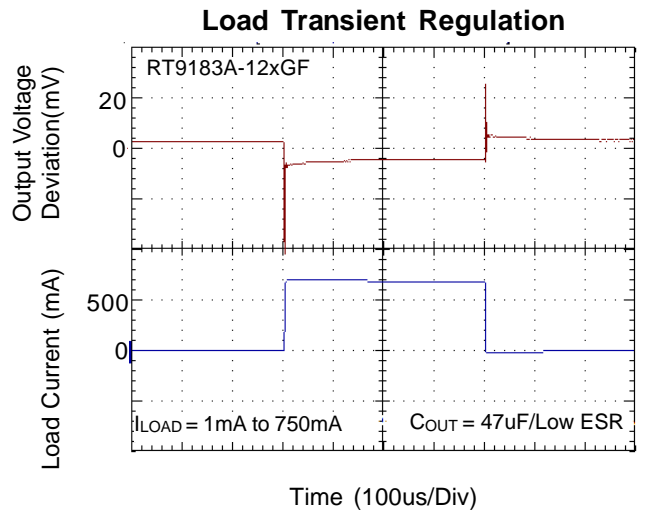
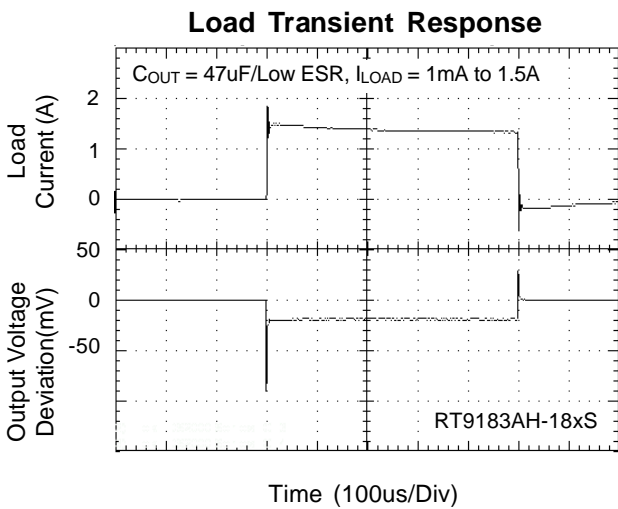
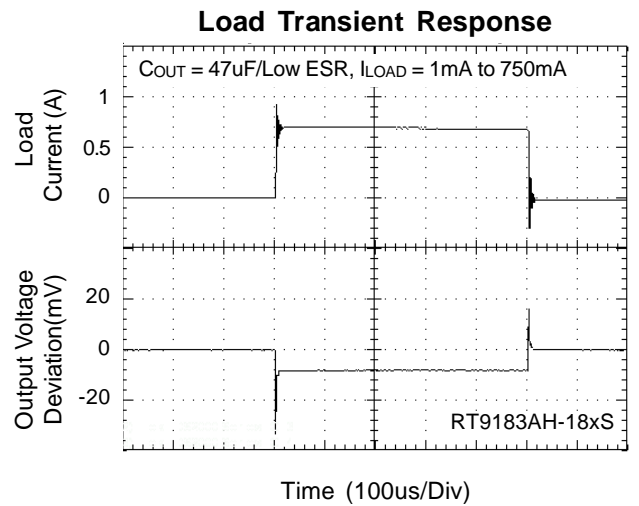
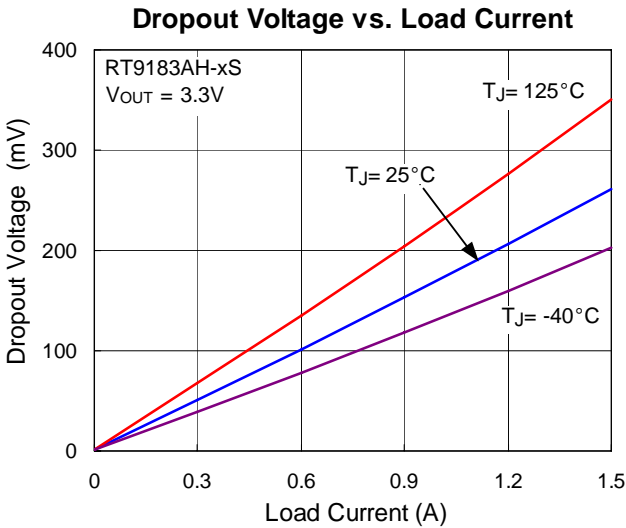
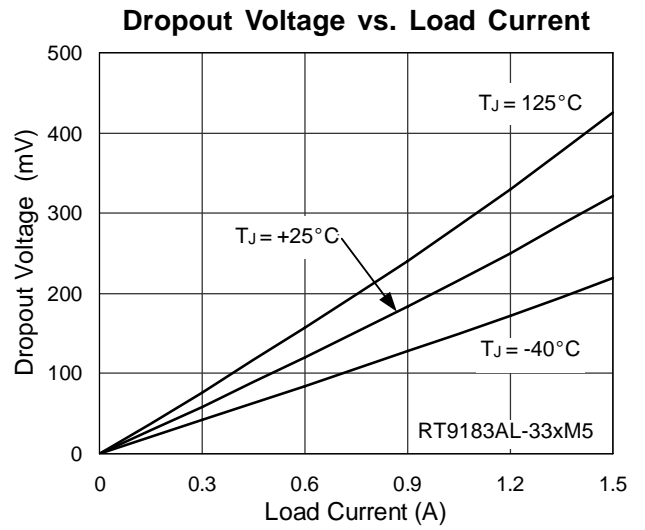
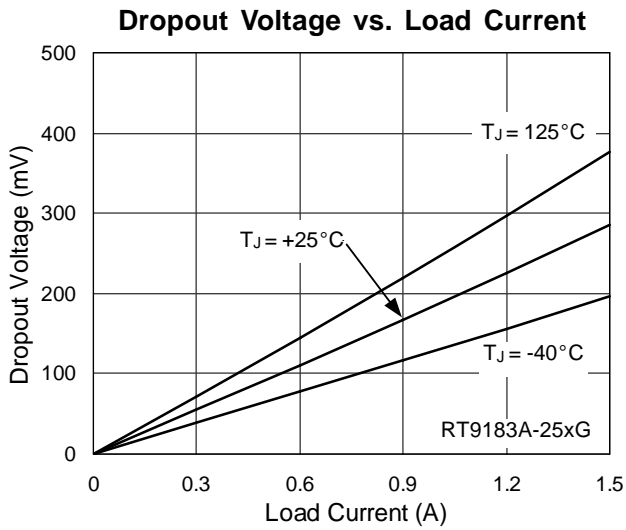

Line Transient Regulation

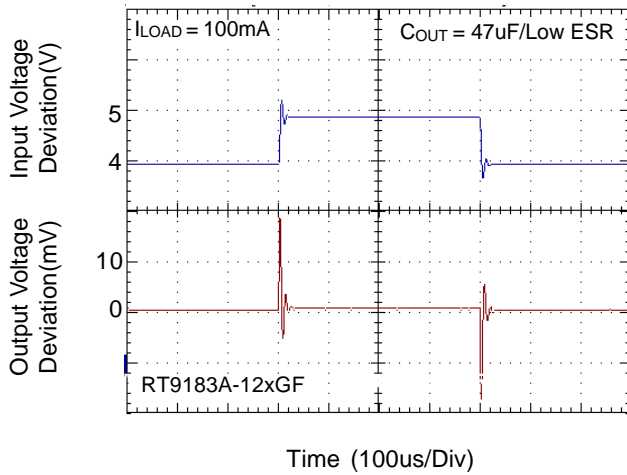

Line Transient Response

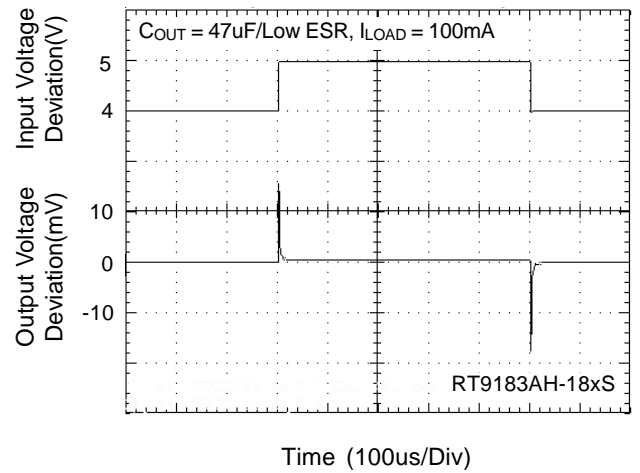

EN Pin Threshold Voltage vs. Temperature

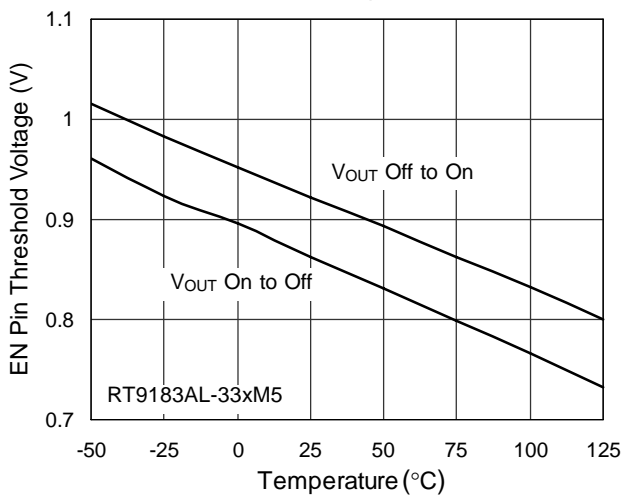

EN Pin Shutdown Response

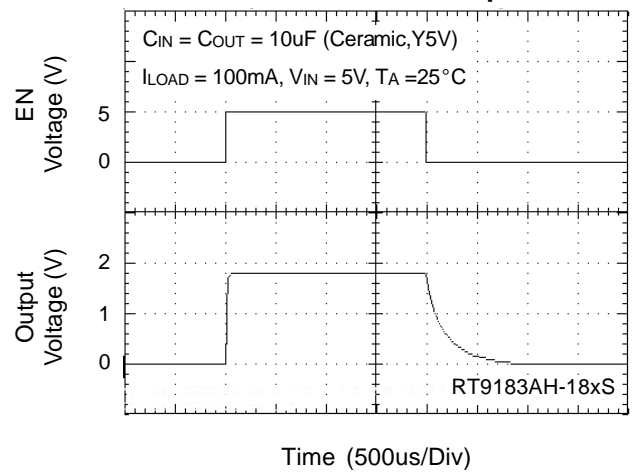

Reference Voltage vs. Temperature

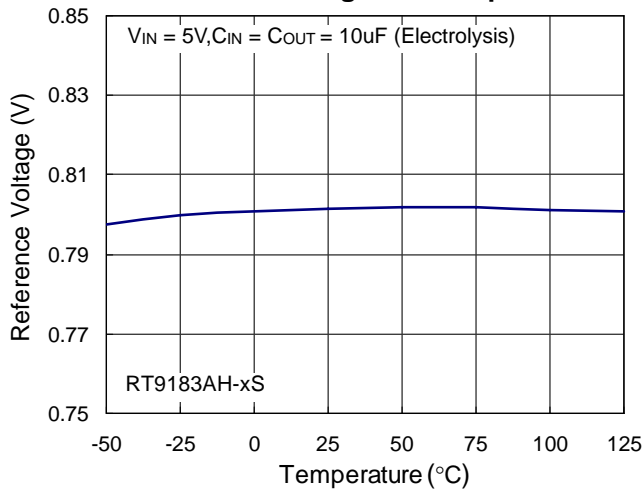

Application Information

Like any low-dropout regulator, the RT9183A series requires input and output decoupling capacitors. These capacitors must be correctly selected for good performance (see Capacitor Characteristics Section). Please note that linear regulators with a low dropout voltage have high internal loop gains which require care in guarding against oscillation caused by insufficient decoupling capacitance.

Input Capacitor

An input capacitance of $\cong 10\mu\text{F}$ is required between the device input pin and ground directly (the amount of the capacitance may be increased without limit). The input capacitor **MUST** be located less than 1 cm from the device to assure input stability (see PCB Layout Section). A lower ESR capacitor allows the use of less capacitance, while higher ESR type (like aluminum electrolytic) require more capacitance.

Capacitor types (aluminum, ceramic and tantalum) can be mixed in parallel, but the total equivalent input capacitance/ ESR must be defined as above to stable operation.

There are no requirements for the ESR on the input capacitor, but tolerance and temperature coefficient must be considered when selecting the capacitor to ensure the capacitance will be $\cong 10\mu\text{F}$ over the entire operating temperature range.

Output Capacitor

The RT9183A is designed specifically to work with very small ceramic output capacitors. The recommended minimum capacitance (temperature characteristics X7R or X5R) are $10\mu\text{F}$ to $47\mu\text{F}$ range with $10\text{m}\Omega$ to $25\text{m}\Omega$ range ceramic capacitors between each LDO output and GND for transient stability, but it may be increased without limit. Higher capacitance values help to improve transient.

The output capacitor's ESR is critical because it forms a zero to provide phase lead which is required for loop stability.

No Load Stability

The device will remain stable and in regulation with no external load. This is specially important in CMOS RAM keep-alive applications.

Input-Output (Dropout) Voltage

A regulator's minimum input-to-output voltage differential (dropout voltage) determines the lowest usable supply voltage. In battery-powered systems, this determines the useful end-of-life battery voltage. Because the device uses a PMOS, its dropout voltage is a function of drain-to-source on-resistance, $R_{\text{DS(ON)}}$, multiplied by the load current :

$$V_{\text{DROPOUT}} = V_{\text{IN}} - V_{\text{OUT}} = R_{\text{DS(ON)}} \times I_{\text{OUT}}$$

Current Limit

The RT9183A monitors and controls the PMOS' gate voltage, minimum limiting the output current to 2A . The output can be shorted to ground for an indefinite period of time without damaging the part.

Short-Circuit Protection

The device is short circuit protected and in the event of a peak over-current condition, the short-circuit control loop will rapidly drive the output PMOS pass element off. Once the power pass element shuts down, the control loop will rapidly cycle the output on and off until the average power dissipation causes the thermal shutdown circuit to respond to servo the on/off cycling to a lower frequency. Please refer to the section on thermal information for power dissipation calculations.

Capacitor Characteristics

It is important to note that capacitance tolerance and variation with temperature must be taken into consideration when selecting a capacitor so that the minimum required amount of capacitance is provided over the full operating temperature range. In general, a good tantalum capacitor will show very little capacitance variation with temperature, but a ceramic may not be as good (depending on dielectric type). Aluminum electrolytics also typically have large temperature variation of capacitance value.

Equally important to consider is a capacitor's ESR change with temperature: this is not an issue with ceramics, as their ESR is extremely low. However, it is very important in tantalum and aluminum electrolytic capacitors. Both show increasing ESR at colder temperatures, but the increase in aluminum electrolytic capacitors is so severe they may not be feasible for some applications.

Ceramic :

For values of capacitance in the 10 μ F to 100 μ F range, ceramics are usually larger and more costly than tantalums but give superior AC performance for by-passing high frequency noise because of very low ESR (typically less than 10m Ω). However, some dielectric types do not have good capacitance characteristics as a function of voltage and temperature.

Z5U and Y5V dielectric ceramics have capacitance that drops severely with applied voltage. A typical Z5U or Y5V capacitor can lose 60% of its rated capacitance with half of the rated voltage applied to it. The Z5U and Y5V also exhibit a severe temperature effect, losing more than 50% of nominal capacitance at high and low limits of the temperature range.

X7R and X5R dielectric ceramic capacitors are strongly recommended if ceramics are used, as they typically maintain a capacitance range within $\pm 20\%$ of nominal over full operating ratings of temperature and voltage. Of course, they are typically larger and more costly than Z5U/Y5U types for a given voltage and capacitance.

Tantalum :

Solid tantalum capacitors are recommended for use on the output because their typical ESR is very close to the ideal value required for loop compensation. They also work well as input capacitors if selected to meet the ESR requirements previously listed.

Tantalums also have good temperature stability: a good quality tantalum will typically show a capacitance value that varies less than 10 to 15% across the full temperature range of 125 $^{\circ}$ C to -40 $^{\circ}$ C. ESR will vary only about 2X going from the high to low temperature limits.

The increasing ESR at lower temperatures can cause oscillations when marginal quality capacitors are used (if the ESR of the capacitor is near the upper limit of the stability range at room temperature).

Aluminum :

This capacitor type offers the most capacitance for the money. The disadvantages are that they are larger in physical size, not widely available in surface mount, and have poor AC performance (especially at higher frequencies) due to higher ESR and ESL.

Compared by size, the ESR of an aluminum electrolytic is higher than either Tantalum or ceramic, and it also varies greatly with temperature. A typical aluminum electrolytic can exhibit an ESR increase of as much as 50X when going from 25 $^{\circ}$ C down to -40 $^{\circ}$ C.

It should also be noted that many aluminum electrolytics only specify impedance at a frequency of 120Hz, which indicates they have poor high frequency performance. Only aluminum electrolytics that have an impedance specified at a higher frequency (between 20kHz and 100kHz) should be used for the device. Derating must be applied to the manufacturer's ESR specification, since it is typically only valid at room temperature.

Any applications using aluminum electrolytics should be thoroughly tested at the lowest ambient operating temperature where ESR is maximum.

Thermal Considerations

Thermal protection limits power dissipation in RT9183A. When the operation junction temperature exceeds 170 $^{\circ}$ C, the OTP circuit starts the thermal shutdown function and turns the pass element off. The pass element turns on again after the junction temperature cools by 30 $^{\circ}$ C.

For continuous operation, do not exceed absolute maximum operation junction temperature 125 $^{\circ}$ C. The power dissipation definition in device is :

$$P_D = (V_{IN} - V_{OUT}) \times I_{OUT} + V_{IN} \times I_Q$$

The maximum power dissipation depends on the thermal resistance of IC package, PCB layout, the rate of surroundings airflow and temperature difference between junction to ambient. The maximum power dissipation can be calculated by following formula :

$$P_{D(MAX)} = (T_{J(MAX)} - T_A) / \theta_{JA}$$

Where $T_{J(MAX)}$ is the maximum operation junction temperature 125°C, T_A is the ambient temperature and the θ_{JA} is the junction to ambient thermal resistance.

For recommended operating conditions specification of RT9183A, where $T_{J(MAX)}$ is the maximum junction temperature of the die (125°C) and T_A is the maximum ambient temperature. The junction to ambient thermal resistance (θ_{JA} is layout dependent) for SOT-223 package is 115°C/W, SOT-223 package (F-Type) is 135°C/W, SOP-8 package is 125°C/W, TO-252 package is 68°C/W, TO-252 package (F-Type) is 75°C/W and TO-263 package is 45°C/W on standard JEDEC 51-3 thermal test board.

The maximum power dissipation depends on operating ambient temperature for fixed $T_{J(MAX)}$ and thermal resistance θ_{JA} . For RT9183A packages, the Figure 4 of derating curves allows the designer to see the effect of rising ambient temperature on the maximum power allowed.

PCB Layout

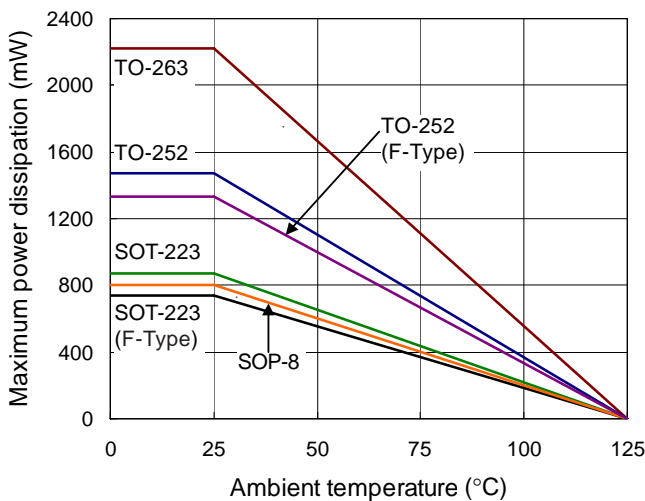

Figure 4

Good board layout practices must be used or instability can be induced because of ground loops and voltage drops. The input and output capacitors **MUST** be directly connected to the input, output, and ground pins of the device using traces which have no other currents flowing through them.

The best way to do this is to layout C_{IN} and C_{OUT} near the device with short traces to the V_{IN} , V_{OUT} , and ground pins.

The regulator ground pin should be connected to the external circuit ground so that the regulator and its capacitors have a "single point ground" .

It should be noted that stability problems have been seen in applications where "vias" to an internal ground plane were used at the ground points of the device and the input and output capacitors. This was caused by varying ground potentials at these nodes resulting from current flowing through the ground plane. Using a single point ground technique for the regulator and it's capacitors fixed the problem. Since high current flows through the traces going into V_{IN} and coming from V_{OUT} , Kelvin connect the capacitor leads to these pins so there is no voltage drop in series with the input and output capacitors.

Optimum performance can only be achieved when the device is mounted on a PC board according to the diagram below :

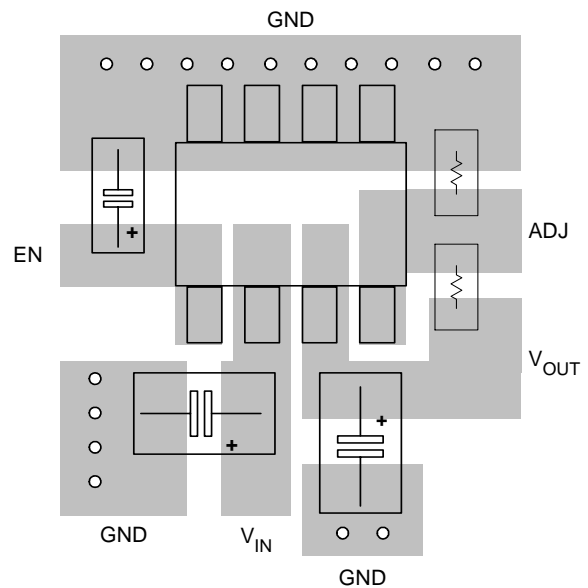

SOP-8 Board Layout

Adjustable Operation

The adjustable version of the RT9183A has an output voltage range of 0.8V to 4.5V. The output voltage is set by the ratio of two external resistors as shown in Figure 2. The value of R2 should be less than 80k to maintain regulation.

In critical applications, small voltage drop is caused by the resistance (R_T) of PC traces between the ground pin of the device and the return pin of R2 (See Figure 5 shown on next page). Note that the voltage drop across the external PC trace will add to the output voltage of the device.

Optimum regulation will be obtained at the point where the return pin of R2 is connected to the ground pin of the device directly.

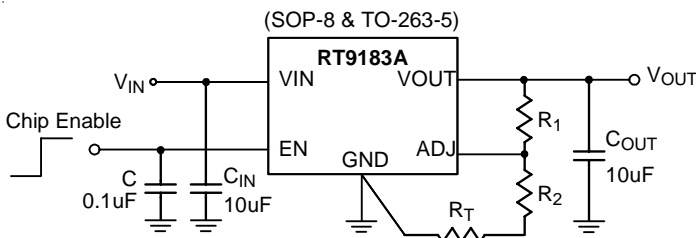
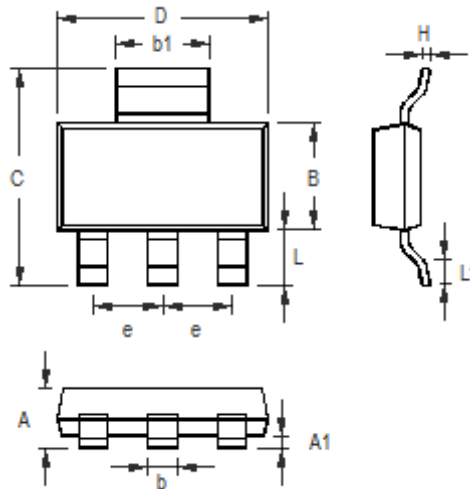

Figure 5. Return Pin of External Resistor Connection

Referring to Figure 3 the fixed voltage versions for both SOP-8 and TO-263-5 packages, the ADJ pin is the input to the error amplifier and **MUST** be tied the ground pin of the device directly otherwise it will be in the unstable state if the pin voltage more than 0.1V with respect to the ground pin itself.

Outline Dimension



Symbol	Dimensions In Millimeters		Dimensions In Inches	
	Min	Max	Min	Max
A	1.400	1.800	0.055	0.071
A1	0.020	0.100	0.001	0.004
b	0.600	0.840	0.024	0.033
B	3.300	3.700	0.130	0.146
C	6.700	7.300	0.264	0.287
D	6.300	6.700	0.248	0.264
b1	2.900	3.100	0.114	0.122
e	2.300		0.091	
H	0.230	0.350	0.009	0.014
L	1.500	2.000	0.059	0.079
L1	0.800	1.100	0.031	0.043

3-Lead SOT-223 Surface Mount Package

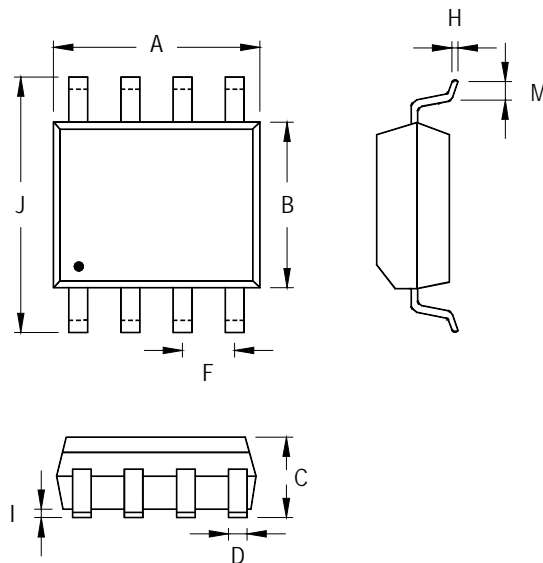

Symbol	Dimensions In Millimeters		Dimensions In Inches	
	Min	Max	Min	Max
A	4.801	5.004	0.189	0.197
B	3.810	3.988	0.150	0.157
C	1.346	1.753	0.053	0.069
D	0.330	0.508	0.013	0.020
F	1.194	1.346	0.047	0.053
H	0.170	0.254	0.007	0.010
I	0.050	0.254	0.002	0.010
J	5.791	6.200	0.228	0.244
M	0.400	1.270	0.016	0.050

8-Lead SOP Plastic Package

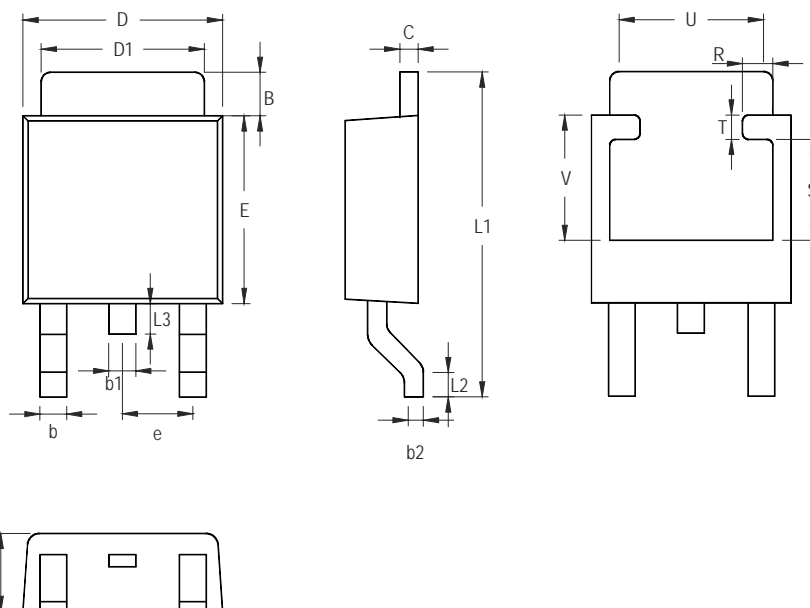

Symbol	Dimensions In Millimeters		Dimensions In Inches	
	Min	Max	Min	Max
A	2.184	2.388	0.086	0.094
B	0.889	2.032	0.035	0.080
b	0.508	0.889	0.020	0.035
b1	1.016 Ref.		0.040 Ref.	
b2	0.457	0.584	0.018	0.023
C	0.457	0.584	0.018	0.023
D	6.350	6.731	0.250	0.265
D1	5.207	5.461	0.205	0.215
E	5.334	6.223	0.210	0.245
e	2.108	2.438	0.083	0.096
L1	9.398	10.414	0.370	0.410
L2	0.508 Ref.		0.020 Ref.	
L3	0.635	1.016	0.025	0.040
U	3.810 Ref.		0.150 Ref.	
V	3.048 Ref.		0.120 Ref.	
R	0.200	0.850	0.008	0.033
S	2.500	3.400	0.098	0.134
T	0.500	0.850	0.020	0.033

3-Lead TO-252 Surface Mount Package

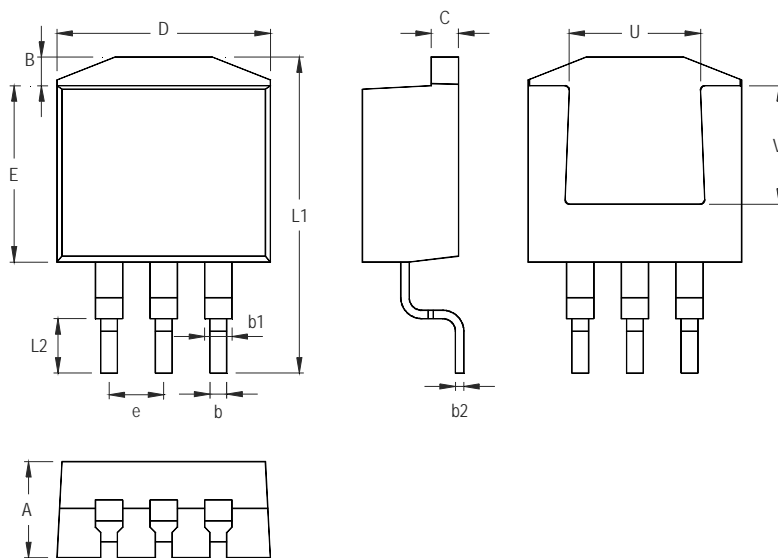

Symbol	Dimensions In Millimeters		Dimensions In Inches	
	Min	Max	Min	Max
A	4.064	4.826	0.160	0.190
B	1.143	1.676	0.045	0.066
b	0.660	0.914	0.026	0.036
b1	1.143	1.397	0.045	0.055
b2	0.305	0.584	0.012	0.023
C	1.143	1.397	0.045	0.055
D	9.652	10.668	0.380	0.420
E	8.128	9.652	0.320	0.380
e	2.286	2.794	0.090	0.110
L1	14.605	15.875	0.575	0.625
L2	2.286	2.794	0.090	0.110
U	6.223 Ref.		0.245 Ref.	
V	7.620 Ref.		0.300 Ref.	

3-Lead TO- 263 Surface Mount

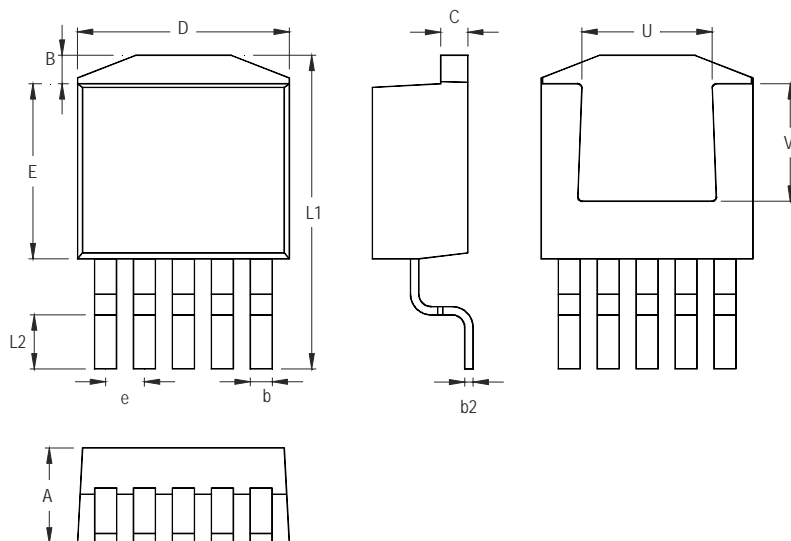

Symbol	Dimensions In Millimeters		Dimensions In Inches	
	Min	Max	Min	Max
A	4.064	4.826	0.160	0.190
B	1.143	1.676	0.045	0.066
b	0.660	0.914	0.026	0.036
b2	0.305	0.584	0.012	0.023
C	1.143	1.397	0.045	0.055
D	9.652	10.668	0.380	0.420
E	8.128	9.652	0.320	0.380
e	1.524	1.829	0.060	0.072
L1	14.605	15.875	0.575	0.625
L2	2.286	2.794	0.090	0.110
U	6.223 Ref.		0.245 Ref.	
V	7.620 Ref.		0.300 Ref.	

5-Lead TO-263 Plastic Surface Mount Package

Richtek Technology Corporation

Headquarter
 5F, No. 20, Taiyuen Street, Chupei City
 Hsinchu, Taiwan, R.O.C.
 Tel: (8863)5526789 Fax: (8863)5526611

Richtek Technology Corporation

Taipei Office (Marketing)
 5F, No. 95, Minchiuan Road, Hsintien City
 Taipei County, Taiwan, R.O.C.
 Tel: (8862)86672399 Fax: (8862)86672377
 Email: marketing@richtek.com

Information that is provided by Richtek Technology Corporation is believed to be accurate and reliable. Richtek reserves the right to make any change in circuit design, specification or other related things if necessary without notice at any time. No third party intellectual property infringement of the applications should be guaranteed by users when integrating Richtek products into any application. No legal responsibility for any said applications is assumed by Richtek.