

High Efficiency Low Noise PFM Step-up DC/DC Converter

DESCRIPTION

BL8534 series are CMOS-based PFM step-up DC-DC Converter. The converter can start up by supply voltage as low as 0.8V, and capable of delivering maximum 200mA output current at 3.3V output with 1.8V input Voltage. Quiescent current drawn from power source is as low as 20uA. All of these features make BL8534 series be suitable for the portable devices, which are supplied by a single battery to four-cell batteries.

To reduce the noise caused by the switch regulator, BL8534 is well considered in circuit design and manufacture, so that the interferer to other circuits by the device is reduced greatly.

BL8534 integrates stable reference circuits and trimming technology, so it can afford high precision and low temperature-drift coefficient of the output voltage.

BL8534 is available in SOT-89-3, SOT-23-3, SOT-23-5 and TO-92 packages that are PB free. And in 5-pin packages, such as SOT-23-5, the device can be switch on or off easily by CE pin, to minimize the standby supply current.

FEATURES

- Deliver 200mA at 3.3V Output voltage with 1.8V input Voltage
- Low start-up voltage (when the output current is 1mA)-----0.8V
- Output voltage can be adjusted from 2.5V to 6.0V (In 0.1V step)
- Output voltage accuracy ----- $\pm 2\%$
- Low temperature-drift coefficient of the output voltage----- $\pm 100\text{ppm}/^\circ\text{C}$
- Only three external components are necessary: An inductor, a Schottky diode and an output filter capacitor
- Low quiescent current drawn from power source----- $<20\mu\text{A}$

APPLICATIONS

- Power Source for PDA, DSC, MP3 Player, Electronic toy and wireless mouse
- Power Source for a Single or Dual-cell Battery-Powered Equipments
- Power Source for LED

TYPICAL APPLICATION

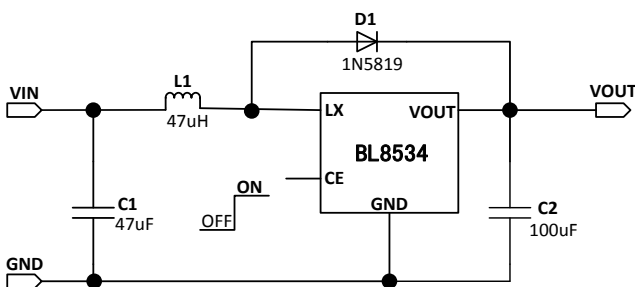

ELECTRICAL CHARACTERISTICS

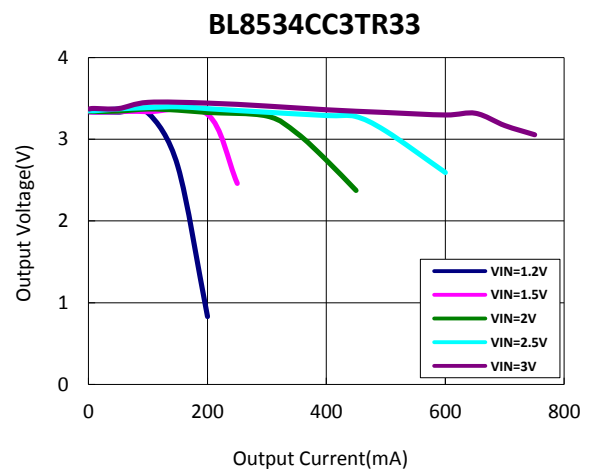

PIN CONFIGURATION

Product Classification	BL8534CB3TR□□
00: Product Code	
XX: Output Voltage	
Product Classification	BL8534CB5TR□□
00: Product Code	
XX: Output Voltage	
Product Classification	BL8534CC3TR□□
LD: Product Code	
XX: Output Voltage	
YY: LOT NO.	
B: FAB Code	
ZZ: Date Code	
Product Classification	BL8534CHBG□□
LD: Product Code	
XX: Output Voltage	
YY: LOT NO.	
B: FAB Code	
ZZ: Date Code	
CE	Chip Enable (Active high)
Vss	Ground
OUT	Output, Power supply for internal
LX	Switching Pin
NC	Not Connected

Z: The Year of manufacturing, "9" stands for year 2009, "0" stands for year 2010;
 Z: The week of manufacturing. "A" stands for week 1, "Z" stands for week 26, "Ā" stands for week 27, "Z̄" stands for week 52.

ORDERING INFORMATION

BL8534 □ □ □ □

Code	Description
□	Temperature & Rohs: C: -40~85°C, Pb Free Rohs Std.
□	Package type: B3: SOT-23-3 B5: SOT-23-5 C3: SOT-89-3 H: TO-92
□	Packing type: TR: Tape & Reel (Standard) BG: Bag (TO-92)
□	Output voltage e.g. 25=2.5V 33=3.3V 60=6.0V

ABSOLUTE MAXIMUM RATING

Parameter		Value
Max Input Voltage		-0.3V-10V
CE Pin Voltage		-0.3V-(Vout+0.3)
Lx Pin Output Current		0.7A
Lx Pin Voltage		10V
Operating Junction Temperature (T _J)		125°C
Ambient Temperature (T _A)		-40°C -85°C
Power Dissipation	SOT-23-3	250mW
	SOT-23-5	250mW
	SOT-89-3	500mW
	TO-92	500mW
Storage Temperature (T _s)		-40°C -150°C
Lead Temperature & Time		260°C, 10Sec

Note:

Exceed these limits to damage to the device.

Exposure to absolute maximum rating conditions may affect device reliability.

RECOMMENDED WORK CONDITIONS

Item	Min	Recommended	Max.	Unit
Input Voltage Range	0.8		Vout	V
Inductor	10		100	μH
Input Capacitor	0	≥10		μF
Output Capacitor	47			μF
Ambient Temperature	-40		85	°C

BLOCK DIAGRAM

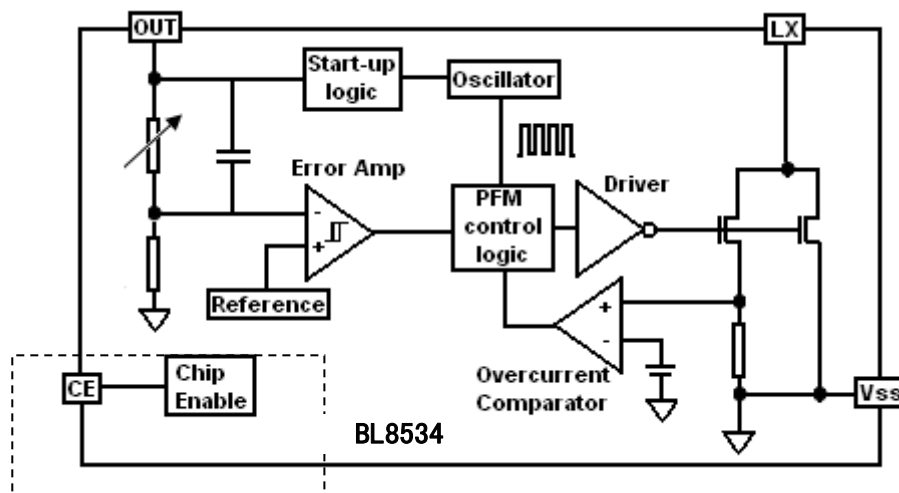

Note: CE pin is only available on 5 pins packages.

ELECTRICAL CHARACTERISTICS

SYMBOL	ITEM	TEST CONDITIONS	REFERENCE DATA			UNIT
			Min	Typ	Max	
Vout_rt	Rated Output Voltage		2.45	2.5	2.55	V
			2.646	2.7	2.754	
			2.94	3.0	3.06	
			3.234	3.3	3.366	
			3.528	3.6	3.672	
			3.92	4.0	4.08	
			4.9	5.0	5.1	
			5.88	6.0	6.12	
Iin	Input Current	Iout=0mA, Vout=Vout*0.6		15	20	uA
Vstart	Start-up Voltage	Iout=1mA, VS: 0→2V		0.8	0.9	V
Vhold	Hold-on Voltage	Iout=1mA, VS: 2→0V	0.6	0.7		V
IDD	Quiescent Current drawn From Power Source	Without external components, Vout =Vout_rt*1.05		4	7	uA
Rswon	Switch ON Resistance			0.8		Ω
ILXleak	LX Leakage Current	Vout=VLx=6V (V _{CE} =0V in 5 pins packages)		0.5	5	uA
VCEH	CE "H" Threshold Voltage	V _{CE} : 0→2V	0.8			V
VCEL	CE "L" Threshold Voltage	V _{CE} : 2→0V			0.3	V
Fosc_max	Oscillator Frequency	LX on "L" side, Vout=Vout_rt*0.96		350		KHz
T _{OFF_MIN}	Minimum Off Time			1.4		uS
Maxdty	Oscillator Duty Cycle	LX on "L" side	70	75	80	%

DETAILED DESCRIPTION

The BL8534 series are boost structure, voltage-type Pulse-Frequency Modulation (PFM) step-up DC-DC converter. Only three external components are necessary: an inductor, an output filter capacitor and a schottky diode. And the converter's low noise and low ripple output voltage can be adjusted from 2.5V to 5.0V, 0.1V step. By using the depletion techniques, the quiescent current drawn from power source is lower than 7uA. The high efficiency device consists of resistors for output voltage detection and trimming, a start-up voltage circuit, an oscillator, a reference circuit, a PFM control circuit, a switch protection circuit and a driver transistor.

The PFM control circuit is the core of the BL8534. This block controls power switch on duty cycle to stabilize output voltage by calculating results of other blocks which sense input voltage, output voltage, output current and load conditions. In PFM modulation system, the frequency and pulse width is fixed. The duty cycle is adjusted by skipping pulses, so that switch on-time is changed based on the conditions such as input voltage, output current and load. The oscillate block

inside BL8534 provides fixed frequency and pulse width wave.

The reference circuit provides stable reference voltage to output stable output voltage. Because internal trimming technology is used, the chip output change less than $\pm 2\%$. At the same time, the problem of temperature-drift coefficient of output voltage is considered in design, so temperature-drift coefficient of output voltage is less than 100ppm/ $^{\circ}\text{C}$.

High-gain differential error amplifiers guarantees stable output voltage at difference input voltage and load. In order to reduce ripple and noise, the error amplifier is designed with high band-with.

Though at very low load condition, the quiescent current of chip do affect efficiency certainly. The four main energy loss of Boost structure DC-DC converter in full load are the ESR of inductor, the voltage of Schottky diode, on resistor of internal N-channel MOSFET and its driver. In order to improve the efficiency, BL8534 integrates low on-resistor N-channel MOSFET and well design driver circuits. The switch energy loss is limited at very low level.

COMPONENTS SELECTION

Thus it can be seen, the inductor and schottky diode affect the conversion efficiency greatly. The inductor and the capacitor also have great influence on the output ripple voltage of the converter. So it is necessary to choose a suitable inductor, a capacitor and a right schottky diode, to obtain high efficiency, low ripple and low noise. Before discussion, we define

$$D \equiv \frac{V_{OUT} - V_{IN}}{V_{OUT}}$$

INDUCTOR SELECTION

Above all, we should define the minimum value of the inductor that can ensure the boost DC-DC to operate in the continuous current-mode condition.

$$L_{MIN} \geq \frac{D(1-D)^2 R_L}{2f}$$

The above expression is got under conditions of continuous current mode, neglect Schottky diode's voltage, ESR of both inductor and capacitor. The actual value is greater that it. If inductor's value is less than Lmin, the efficiency of DC-DC converter will drop greatly, and the DC-DC circuit will not be stable.

Secondly, consider the ripple of the output voltage,

$$\Delta I = \frac{DV_{IN}}{Lf}$$

$$I_{MAX} = \frac{V_{IN}}{(1-D)^2 R_L} + \frac{DV_{IN}}{2Lf}$$

If inductor value is too small, the current ripple through it will be great. Then the current through diode and power switch will be great. Because the power switch on chip is not ideal switch, the energy of switch will improve. The efficiency will fall.

Thirdly, in general, smaller inductor values supply more output current while larger values start up with lower input voltage and acquire high efficiency.

An inductor value of 3uH to 1mH works well in most applications. If DC-DC converter delivers large output current (for example: output current is great than 50mA), large inductor value is recommended in order to improve efficiency. If DC-DC must output very large current at low input supply voltage, small inductor value is recommended.

The ESR of inductor will affect efficiency greatly. Suppose ESR value of inductor is r_L , R_{load} is load resistor, then the energy can be calculated by following expression :

$$\Delta\eta \approx \frac{r_L}{R_{load}(1-D)^2}$$

For example: input 1.5V, output is 3.0V, $R_{load}=20\Omega$, $r_L=0.5\Omega$, the energy loss is 10%.

Consider all above, inductor value of 47uH、ESR<0.5Ω is recommended in most applications. Large value is recommended in high efficiency applications and smaller value is recommended

CAPACITOR SELECTION

Ignore ESR of capacitor, the ripple of output voltage is:

$$r = \frac{\Delta V_{OUT}}{V_{OUT}} = \frac{D}{R_{LOAD}Cf}$$

So large value capacitor is needed to reduce ripple. But too large capacitor value will slow down system reaction and cost will improve. So 100uF capacitor is recommended. Larger capacitor value will be used in large output current system. If output current is small (<10mA), small value is needed.

Consider ESR of capacitor, ripple will increase:

$$r' = r + \frac{I_{MAX} R_{ESR}}{V_{OUT}}$$

When current is large, ripple caused by ESR will be main factor. It may be greater than 100mV. The ESR will affect efficiency and increase energy loss. So low-ESR capacitor (for example: tantalum capacitor) is recommend or connects two or more filter capacitors in parallel.

DIODE SELECTION

Rectifier diode will affects efficiency greatly, Though a common diode (such as 1N4148) will work well for light load, it will reduce about 5%~10% efficiency for heavy load, For optimum performance, a Schottky diode (such as 1N5817、1N5819、1N5822) is recommended.

TEST CIRCUITS

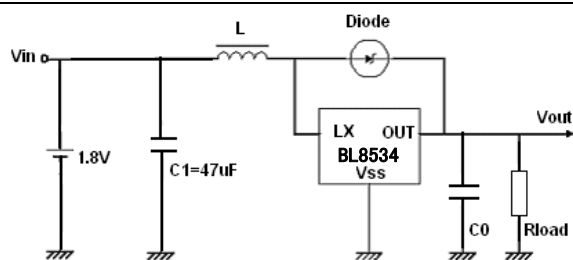

Figure 1: Output voltage test circuit ($I_{OUT}=1mA$)

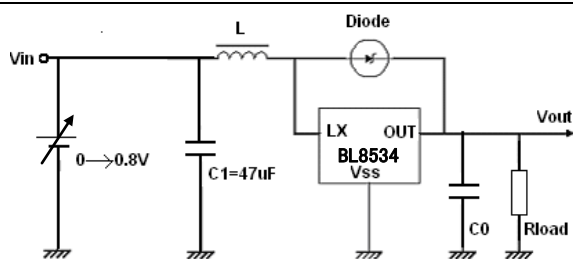

Figure 2: Start-up voltage test circuit ($I_{OUT}=1mA$)

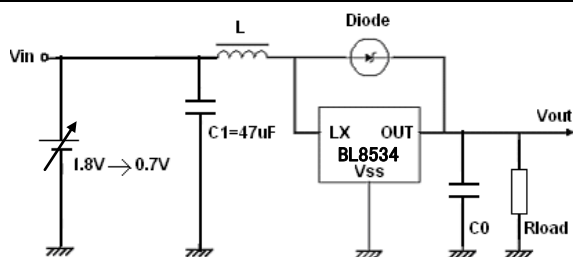

Figure 3: Hold-on voltage test circuit ($I_{OUT}=1mA$)

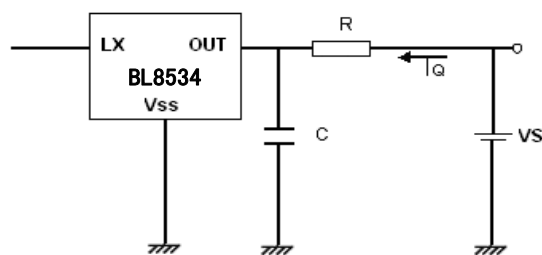

Figure 4: Quiescent current test circuit ($V_S=V_{out_rt} * 1.05$, $R=1K\Omega$, $C=0.1\mu F$)

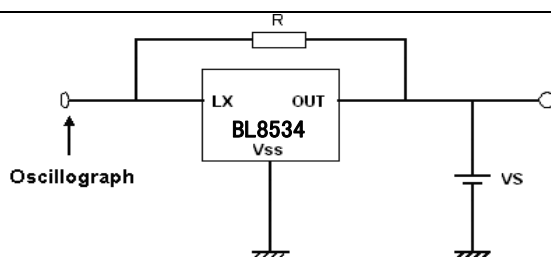
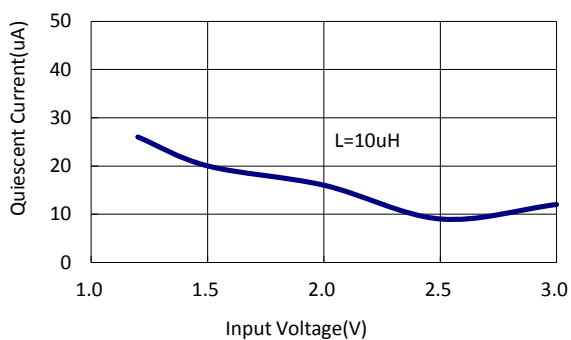

Figure 5: Oscillator frequency and duty cycle test circuit ($V_S=V_{out_rt} * 0.95$, $R=1K\Omega$)

TYPICAL PERFORMANCE CHARACTERISTICS

Recommended operating conditions: $C_{in}=47\mu F$, $C_{out}=100\mu F$, $T_{opt}=25^{\circ}C$. (Unless otherwise noted)
 And all the tests below are made on BL8534CC3TR33.

Quiescent Current VS Input Voltage



Quiescent Current VS Input Voltage

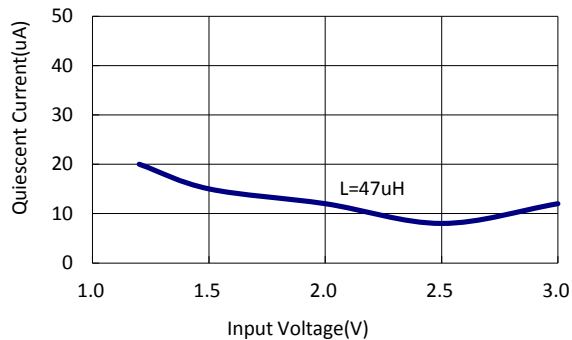

Output Voltage VS Output Current

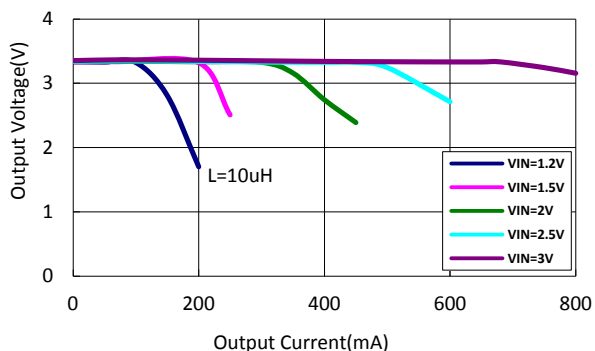

Output Voltage VS Output Current

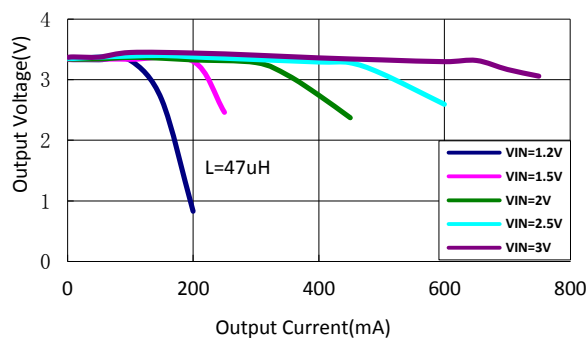

Efficiency VS Load Current

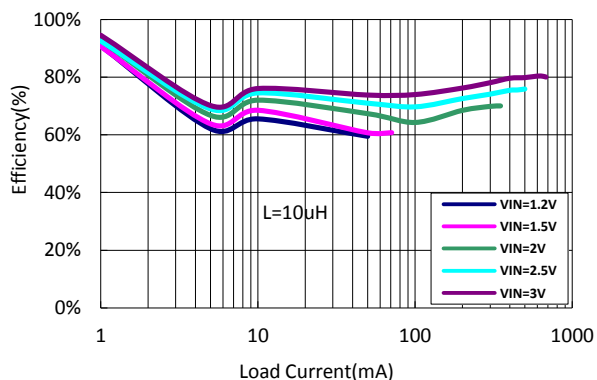

Efficiency VS Load Current

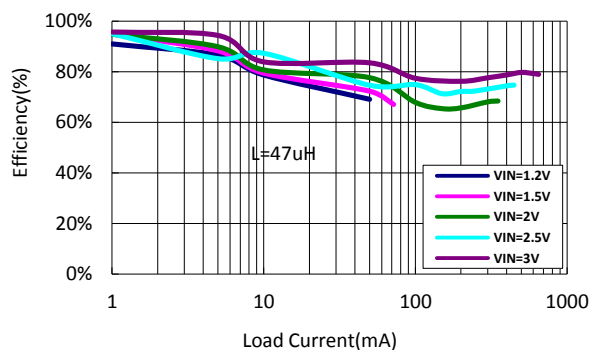

TYPICAL PERFORMANCE CHARACTERISTICS (Continued)

Recommended operating conditions: $C_{in}=47\mu F$, $C_{out}=100\mu F$, $T_{opt}=25^{\circ}C$. (Unless otherwise noted)
 And all the tests below are made on BL8534CC3TR33.

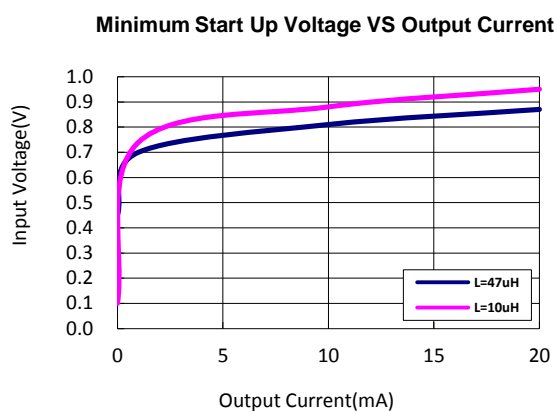
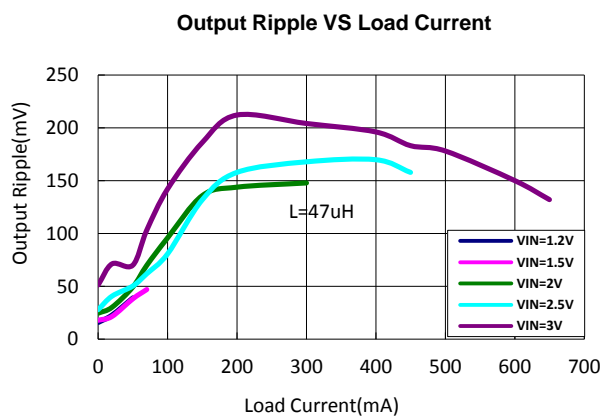
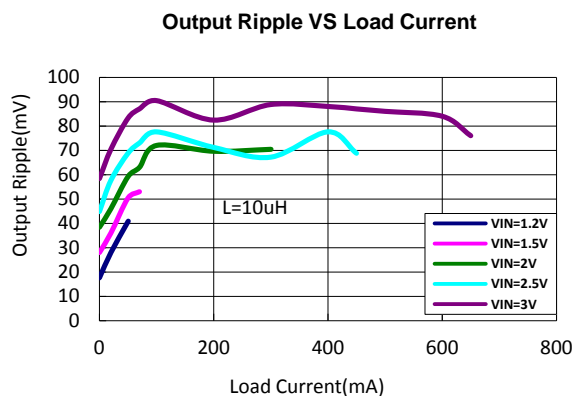

PACKAGE LINE

Package	SOT-23-3	Devices per reel	3000Pcs	Unit	mm
Package dimension:					
<p>Technical drawing of the SOT-23-3 package. It includes three views: a top view, a side view, and a cross-sectional view. The top view shows a rectangular body with a width of 1.900 ± 0.05 mm and a total length of 2.400 ± 0.05 mm. The distance between the two leads is 1.300 ± 0.05 mm. The lead length is 0.550 ± 0.05 mm. The lead thickness is 0.400 ± 0.03 mm. The lead width is 0.400 ± 0.05 mm. The lead tip radius is $4 \times R0.1$ MAX. The side view shows a total length of 2.900 ± 0.05 mm and a lead length of 1.000 ± 0.05 mm. The lead tip radius is $4 \times R0.1$ MAX. The cross-sectional view shows a lead thickness of 0.2 MIN, a lead width of $0.100^{+0.05}_{-0.01}$ mm, and a lead tip radius of $R0.08$. The lead tip width is 0.080 ± 0.02 mm. The lead tip height is 0.1 mm. The lead tip radius is $4 \times R0.1$ MAX. The lead tip width is 2×7 mm.</p>					

Package	SOT-23-5	Devices per reel	3000Pcs	Unit	mm
Package dimension:					
<p>Technical drawing of the SOT-23-5 package. It includes three views: a top view, a side view, and a perspective view. The top view shows a rectangular body with a width of 2.9 ± 0.2 mm and a total length of 1.9 ± 0.2 mm. The distance between the two leads is $1.6^{+0.2}_{-0.1}$ mm. The lead length is 2.8 ± 0.3 mm. The lead thickness is 0.4 ± 0.1 mm. The lead tip radius is $4 \times R0.1$ MAX. The side view shows a total length of $1.1^{+0.2}_{-0.1}$ mm and a lead length of 0.8 ± 0.1 mm. The lead tip radius is $R0.08$. The lead tip width is $0.15^{+0.1}_{-0.05}$ mm. The lead tip height is 0.2 MIN. The lead tip radius is $4 \times R0.1$ MAX. The lead tip width is 2×7 mm. The perspective view shows the package from an isometric perspective.</p>					

PACKAGE LINE (Continued)

Package	SOT-89-3	Devices per reel	1000Pcs	Unit	mm
Package dimension:					
<p>Technical drawing of the SOT-89-3 package. The top view shows a rectangular body with a width of 4.5 ± 0.1 mm and a central circular hole with a diameter of $\varnothing 1.0$ mm. The distance from the center of the hole to the left edge is 1.6 ± 0.2 mm. The package has three leads labeled 1, 2, and 3. The distance from the center of the hole to the center of lead 1 is 0.8 mm (MIN.), and to lead 3 is 2.5 ± 0.1 mm. The total height of the package is 4.25 mm (MAX.). The side view shows a height of 1.5 ± 0.1 mm for the top section and a lead height of 0.4 ± 0.1 mm. The bottom view shows a trapezoidal shape with a width of 1.5 ± 0.1 mm between the two inner leads and 1.5 ± 0.1 mm between the two outer leads. The distance from the center of the hole to the left edge of the bottom view is 0.42 ± 0.2 mm, and to the right edge is 0.47 ± 0.1 mm.</p>					

Package	TO-92	Devices per Bag	1000Pcs	Unit	mm
Package dimension:					
<p>Technical drawing of the TO-92 package. The front view shows a cylindrical body with a diameter of $\varnothing 4.5 \pm 0.1$ mm and a height of 4.95 ± 0.35 mm. The distance from the center of the body to the center of the lead is 0.46 mm. The lead has a diameter of 0.5 mm and a length of 14.3 ± 0.1 mm. The top view shows a circular body with a diameter of $\varnothing 1.5 \times 0.2$ mm. The distance from the center of the body to the center of the lead is 2.54 mm. The height of the body is 3.5 ± 0.1 mm, and the distance from the center of the body to the center of the lead is 1.25 ± 0.1 mm. The lead has a diameter of 0.38 mm.</p>					