

## 3A 1.5MHz 5.5V Synchronous Buck Converter

### DESCRIPTION

The BL8529 is a high efficiency synchronous, buck DC/DC converter. Its input voltage range is from 2.6V to 6V and provides an adjustable regulated output voltage from 0.8V to 5.5V while delivering up to 3A of output current.

The internal synchronous switches increase efficiency and eliminate the need for an external Schottky diode. The switching frequency is set by an external resistor or can be synchronized to an external clock. The 100% duty cycle provides low dropout operation extending battery life in portable systems.

The BL8529 is operated in PFM/PWM auto-switch mode which enhance the efficiency at light-load.

The BL8529 is available in the DFN2x2-8L and DFN3x3-10L package

### FEATURES

- Adjustable Output Voltage,  $V_{fb}=0.8V$
- Maximum output current is 3A
- Range of operation input voltage: Max 6V
- Standby current: 0.5mA (typ.)
- Line regulation: 0.1%/V (typ.)
- Load regulation: 10mV (typ.)
- High efficiency, up to 96%
- Environment Temperature:  $-20^{\circ}C\sim 85^{\circ}C$

### APPLICATIONS

- Power Management for 3G modem
- 3W LED driver from Li-ion battery
- LCD Monitor and LCD TV
- DVD Decode Board
- ADSL Modem
- Post Regulators for Switching Supplies

### TYPICAL APPLICATION

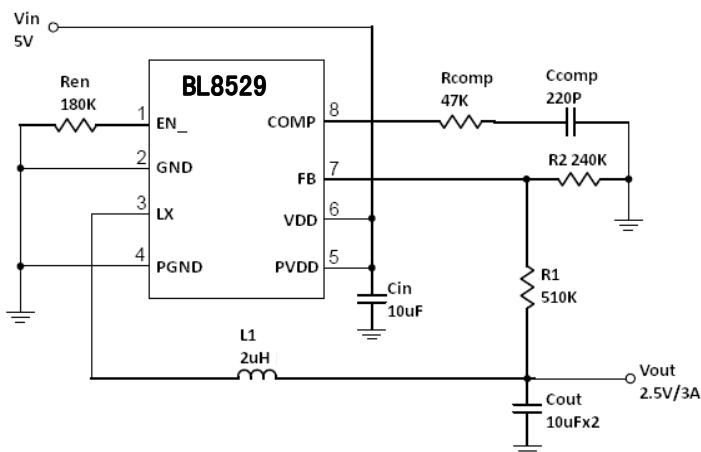

### PIN OUT & MARKING

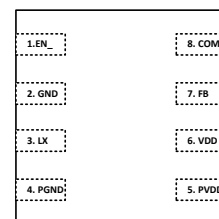

DFN2x2-8L

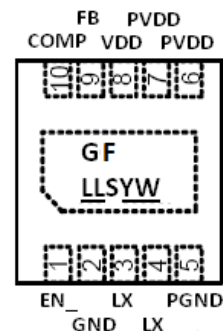

DFN3X3-10

## ORDERING INFORMATION

Part No.	Package	Tape&Reel
BL8529CKBTR	DFN2x2-8L	3000/Reel
BL8529CKATR	DFN3x3-10L	3000/Reel

## ABSOLUTE MAXIMUM RATING

Parameter	Value
Max Input Voltage	6V
Max Operating Junction Temperature(Tj)	125°C
Ambient Temperature(Ta)	-20°C – 85°C
Package Thermal Resistance	DFN2x2-8L 25°C / W
Storage Temperature(Ts)	-40°C - 150°C
Lead Temperature & Time	260°C, 10S
ESD (HBM)	>2000V

**Note:** Exceed these limits to damage to the device. Exposure to absolute maximum rating conditions may affect device reliability.

## RECOMMENDED WORK CONDITIONS

Parameter	Value
Input Voltage Range	Max. 6V
Operating Junction Temperature(Tj)	-20°C –125°C

## ELECTRICAL CHARACTERISTICS

(VDD=5V, TA=25°C)

Symbol	Parameter	Conditions	Min	Typ	Max	Unit
VDD	Input Voltage Range		2.6		5.5	V
Vref	Feedback Voltage		0.784	0.8	0.816	V
I <sub>fb</sub>	Feedback Leakage current			0.1	0.4	uA
I <sub>q</sub>	Quiescent Current	Active, V <sub>fb</sub> =0.78, No Switching		450		uA
		Shutdown		1		uA
LnReg	Line Regulation	V <sub>in</sub> =4V to 5.5V		0.1		%/V
LdReg	Load Regulation	I <sub>out</sub> =1 to 3A		0.02		%/A
G <sub>m</sub>	EA Transconductance			600		us
F <sub>soc</sub>	Switching Frequency	R <sub>en_</sub> =180K		1.35		MHz
R <sub>dsonP</sub>	PMOS R <sub>dson</sub>			150		mohm
R <sub>dsonN</sub>	NMOS R <sub>dson</sub>			130		mohm
I <sub>limit</sub>	Peak Current Limit			3.8		A
V <sub>en_</sub>	EN_ Shutdown Voltage		V <sub>in</sub> -0.7V		V <sub>in</sub>	

## TYPICAL PERFORMANCE CHARACTERISTICS

### Efficiency vs. Output Current

(V<sub>OUT</sub>=1.0V)

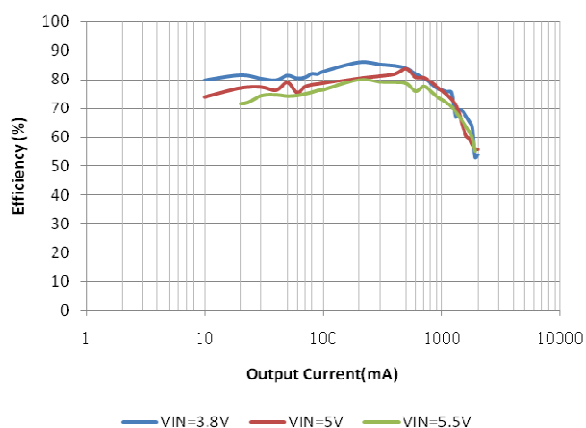

### Load Regulation

(V<sub>OUT</sub>=1.0V)

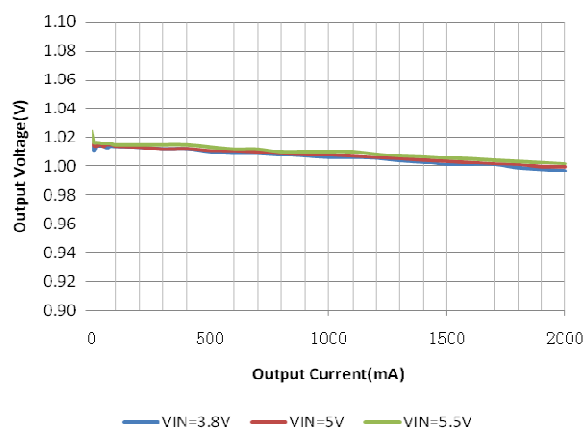

### Efficiency vs. Output Current

(V<sub>OUT</sub>=3.3V)

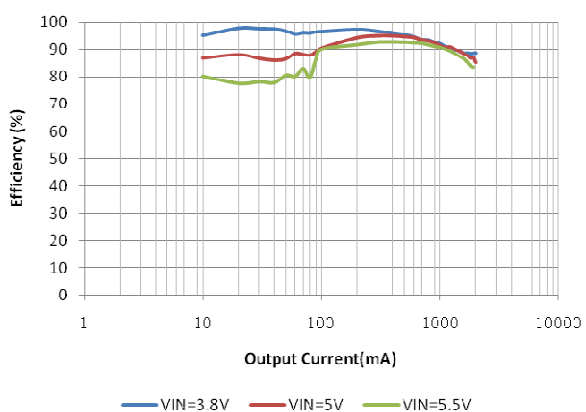

### Load Regulation

(V<sub>OUT</sub>=3.3V)

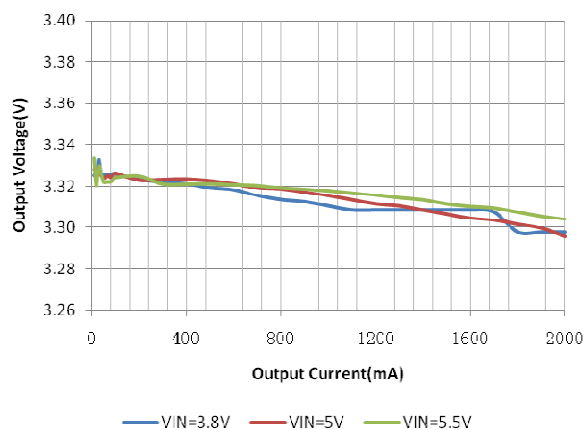

### Quiescent Current vs. Input Voltage

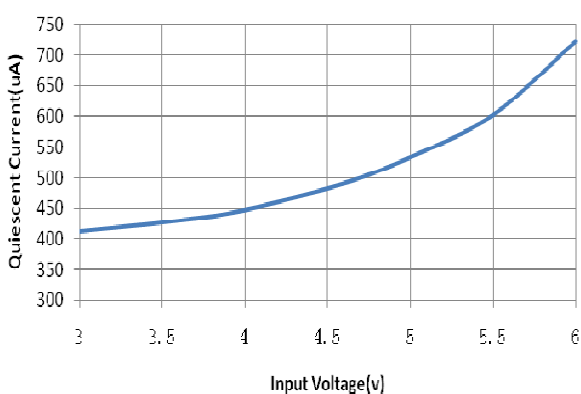

### Current Limit vs. Input Voltage

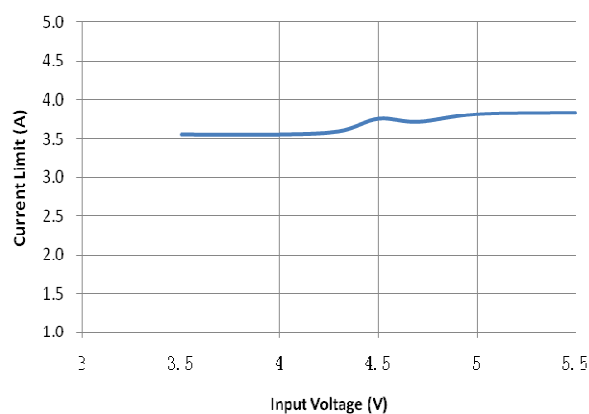

## TYPICAL PERFORMANCE CHARACTERISTICS cont'

### Frequency vs. Temperature

(VIN=5V)

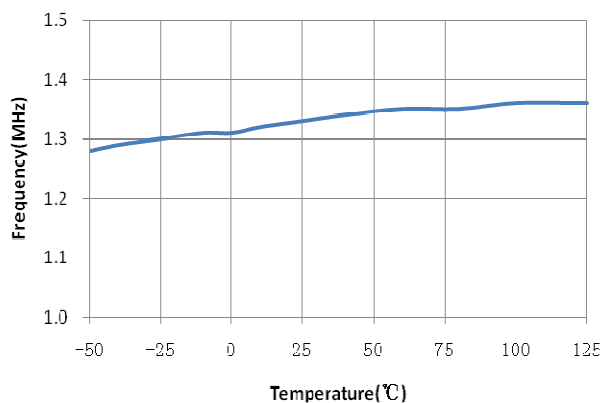

### Output Voltage vs. Temperature

(VIN=5V)

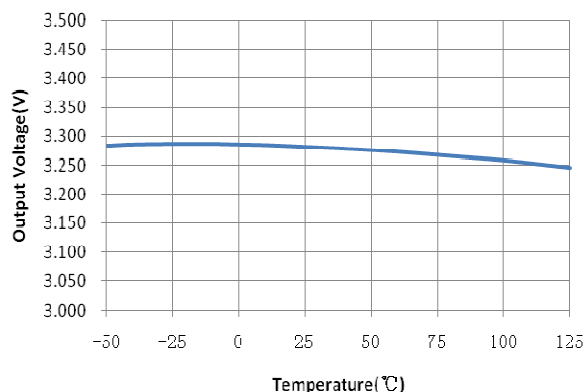

### Power On & Soft Start

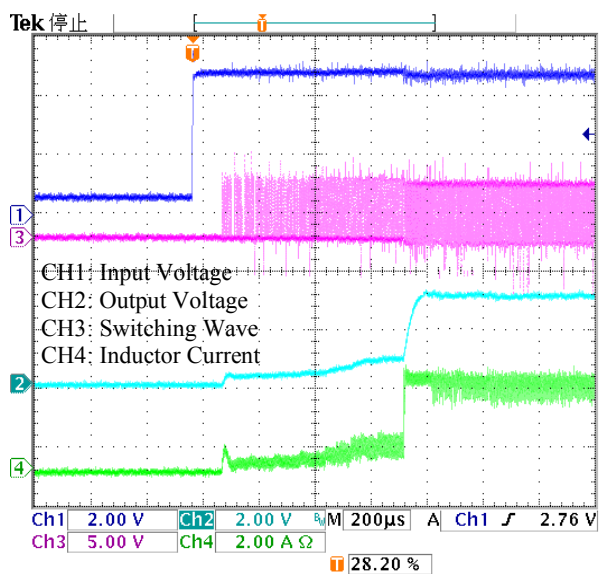

### Load Transient Response

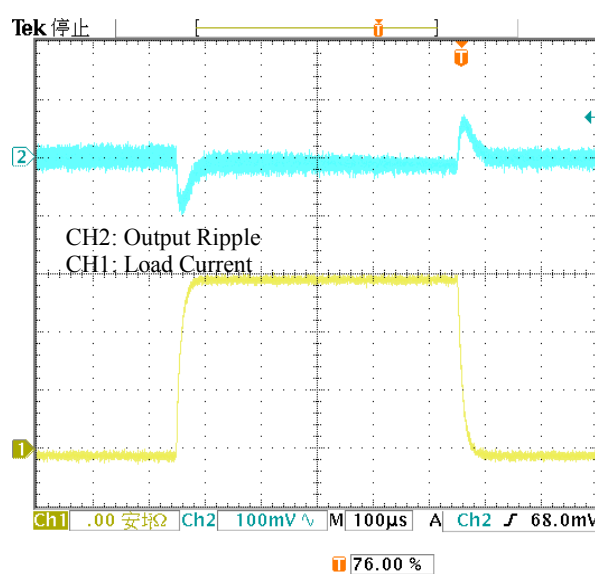

## DETAILED DESCRIPTION

BL8529 is a 3A synchronous buck, with frequency adjusted by Ren\_. It can achieve conversion efficiency up to 95%. It also support 100% duty cycle which will maximize the battery usage. Only a inductor and a few R & C need for peripheral. The PCB size can be very small

Please note that EN\_ pin has to be pull high if one wants to shutdown the chip. And release it (with a Ren\_ connected to GND) to have it work. One can also switch off BL8529 by connect enable signal with at least 1mA driving capability to VDD pin (pin 6 of DFN2x2 and pin 8 of DFN3x3 package).

## PACKAGE OUTLINE

Package	DFN2x2-8L	Devices per reel	3000	Unit	mm																																																			
Package specification:																																																								
		<table border="1"> <thead> <tr> <th colspan="4">COMMON DIMENSIONS(MM)</th> </tr> <tr> <th rowspan="2">PKG. REF.</th> <th colspan="3">W: VERY VERY THIN</th> </tr> <tr> <th>MIN.</th> <th>NOM.</th> <th>MAX.</th> </tr> </thead> <tbody> <tr> <td>A</td> <td>0.70</td> <td>0.75</td> <td>0.80</td> </tr> <tr> <td>A1</td> <td>0.00</td> <td>—</td> <td>0.05</td> </tr> <tr> <td>A3</td> <td colspan="3">0.2 REF.</td> </tr> <tr> <td>D</td> <td>1.95</td> <td>2.00</td> <td>2.05</td> </tr> <tr> <td>E</td> <td>1.95</td> <td>2.00</td> <td>2.05</td> </tr> <tr> <td>b</td> <td>0.18</td> <td>0.23</td> <td>0.30</td> </tr> <tr> <td>L</td> <td>0.25</td> <td>0.35</td> <td>0.45</td> </tr> <tr> <td>D2</td> <td>1.05</td> <td>1.20</td> <td>1.30</td> </tr> <tr> <td>E2</td> <td>0.45</td> <td>0.60</td> <td>0.70</td> </tr> <tr> <td>e</td> <td colspan="3">0.50 BSC</td> </tr> </tbody> </table>				COMMON DIMENSIONS(MM)				PKG. REF.	W: VERY VERY THIN			MIN.	NOM.	MAX.	A	0.70	0.75	0.80	A1	0.00	—	0.05	A3	0.2 REF.			D	1.95	2.00	2.05	E	1.95	2.00	2.05	b	0.18	0.23	0.30	L	0.25	0.35	0.45	D2	1.05	1.20	1.30	E2	0.45	0.60	0.70	e	0.50 BSC		
COMMON DIMENSIONS(MM)																																																								
PKG. REF.	W: VERY VERY THIN																																																							
	MIN.	NOM.	MAX.																																																					
A	0.70	0.75	0.80																																																					
A1	0.00	—	0.05																																																					
A3	0.2 REF.																																																							
D	1.95	2.00	2.05																																																					
E	1.95	2.00	2.05																																																					
b	0.18	0.23	0.30																																																					
L	0.25	0.35	0.45																																																					
D2	1.05	1.20	1.30																																																					
E2	0.45	0.60	0.70																																																					
e	0.50 BSC																																																							

Package	DFN3x3-10L	Devices per reel	3000	Unit	mm																																			
Package specification:																																								
		<table border="1"> <thead> <tr> <th rowspan="2">Symbol</th> <th colspan="2">Dimensions In Millimeters</th> </tr> <tr> <th>Min</th> <th>Max</th> </tr> </thead> <tbody> <tr> <td>A</td> <td>0.700</td> <td>0.800</td> </tr> <tr> <td>A1</td> <td>0.000</td> <td>0.050</td> </tr> <tr> <td>A3</td> <td>0.175</td> <td>0.250</td> </tr> <tr> <td>b</td> <td>0.180</td> <td>0.300</td> </tr> <tr> <td>D</td> <td>2.950</td> <td>3.050</td> </tr> <tr> <td>D2</td> <td>2.300</td> <td>2.650</td> </tr> <tr> <td>E</td> <td>2.950</td> <td>3.050</td> </tr> <tr> <td>E2</td> <td>1.500</td> <td>1.750</td> </tr> <tr> <td>e</td> <td colspan="2">0.500</td> </tr> <tr> <td>L</td> <td>0.350</td> <td>0.450</td> </tr> </tbody> </table>				Symbol	Dimensions In Millimeters		Min	Max	A	0.700	0.800	A1	0.000	0.050	A3	0.175	0.250	b	0.180	0.300	D	2.950	3.050	D2	2.300	2.650	E	2.950	3.050	E2	1.500	1.750	e	0.500		L	0.350	0.450
Symbol	Dimensions In Millimeters																																							
	Min	Max																																						
A	0.700	0.800																																						
A1	0.000	0.050																																						
A3	0.175	0.250																																						
b	0.180	0.300																																						
D	2.950	3.050																																						
D2	2.300	2.650																																						
E	2.950	3.050																																						
E2	1.500	1.750																																						
e	0.500																																							
L	0.350	0.450																																						